

AN/PRC-150(C)

***HIGH-FREQUENCY
MANPACK RADIO***



APPLICATIONS HANDBOOK



FALCON II SERIES
THE NEXT GENERATION

A stylized black silhouette of a falcon in flight, perched on a rectangular base.

AN/PRC-150(C) Radio System

Introduction

For missions requiring reliable, long-range communications equipment, Harris has developed the FALCON® II AN/PRC-150(C), the most advanced HF manpack radio in the world today. The AN/PRC-150(C) is certified by the National Security Agency (NSA) for its embedded information security features. It is designed to meet the demanding security requirements of military forces worldwide.

This radio also utilizes the latest technology to embed many advanced features that used to require separate components, such as Automatic Link Establishment (ALE), high-speed modems, as well as Type I encryption. And being a software-defined radio helps make the FALCON II radios future proof. As new technology and waveforms are developed, you can upgrade your FALCON II systems to be compatible with future radios such as the Joint Tactical Radio System (JTRS) radios...and they will remain compatible with your radios currently in the field.

The AN/PRC-150(C) manpack is the basic building block for our HF systems. The FALCON II family also includes power amplifiers and antenna couplers. Our systems can be packaged for vehicular, transit case, or base station applications and we offer a number of accessories and antennas to complete your system.

This applications handbook defines the AN/PRC-150(C) radios and their components, and also helps with your selection of antennas and accessories.



AN/PRC-150(C)



The AN/PRC-150(C) is an advanced HF/VHF manpack radio that provides reliable tactical communications through US Government Type 1 encryption for enhanced secure voice and data performance, reduced size/weight, and extended battery life. The removable keypad/display unit enables operation on-the-move with the transceiver stowed in the user's backpack. The AN/PRC-150(C) HF-SSB/VHF-FM transceiver covers 1.6 to 60 MHz at 1, 5, and 20 watts (10 watts FM) PEP/Average. Modes include USB, LSB, CW, AME, and FM. Two types of encryption are included in this radio: US Government Type 1 and Coalition encryption.

A simple, menu-driven, man-machine interface makes operation easy. Seventy-five user defined net presets provide complete radio configuration including radio operating mode, modem settings, COMSEC and TRANSEC keys. This unit is interoperable with non-type 1 radios in secure mode with radios that include standard Citadel® encryption in both the HF and VHF bands. The unit is also interoperable in non-secure mode in fixed frequency and ALE with other HF and VHF radio systems.

Key features include:

Encryption

Two types of embedded encryption are included in this radio: US Government Type 1 and Coalition. The Type 1 encryption is interoperable with KY-99, KY-100, and KG-84 cryptos for HF systems and KY-57 crypto for VHF systems. Coalition encryption is based on the Harris Citadel encryption and can be used to interoperate with RF-5800H radio systems in secure mode.

High-Speed Modem Waveforms

The embedded modem waveform suite offers the most advanced HF data capability available in the tactical radio market place. The supported MIL-STD-188-110B waveforms include the serial-tone (2400 bps) modem, high-data rate (9600 bps) modem, parallel-tone (2400 bps) modem, as well as a set of narrowband FSK waveforms. Also included are the STANAG 4285 and STANAG 4415 serial-tone waveforms. Adaptive excision filtering and equalization improve the data modem performance in fading and noisy channels, and counteracts jamming.

MELP and LPC-10, 600/2400 bps digital voice

The digital voice mode utilizes the latest military MELP and LPC-10 algorithms for high-quality secure narrowband voice at 2400 bps. The Harris 600 bps vocoders extend the communication range beyond conventional 2400 bps systems.

Enhanced Frequency Hopping (ECCM)

A proprietary serial-tone ECCM provides digital voice and data performance comparable to single channel serial tone modem.

MIL-STD-188-141B, Appendix A Automatic Link Establishment (ALE)

ALE allows the transceiver to automatically locate the best available channel and link with a desired station or net. The radio also provides AL-1 Linking Protection.

STANAG 4538 Third generation HF Link Automation

Latest integrated high performance Automated Link Establishment (ALE) and data link protocols. Provides superior linking and error-free data performance. Fast link setup (FLSU) protocol suite is supported.

Tactical Internet

An embedded wireless networking capability provides the ability to connect outside IPV4 devices and applications over HF circuits. It utilizes 3rd generation HF Link Automation to efficiently route secure IP-based traffic.

The AN/PRC-150(C) includes:

- R/T-1694 Manpack Radio
- Battery Box 10513-4800-02
- Manual 10515-0103-4100
- Handset 10075-1399
- Whip Antenna 10372-0240-02
- Ground Stake Kit 10303-1008-01
- 6 Foot KDU Extension Cable 10511-0704-012
- Audio Y Adapter Cable 10372-1230
- Data Cable 10535-0775-A006
- Backpack 10530-0460-01
- CW Key 919-5004-03
- Radio Programming Application RF-6550H
- Tactical Chat Software RF-6551H

AN/PRC-150(C) Radio System

20-Watt Systems

RF-5800H-V005 Vehicular System



Specifications

- Uses RF-5830H-PA001 External Amplifier/Antenna Coupler
- 20-watt PEP/ Average
- 1.6 to 30 MHz
- 30 to 60 MHz FM Operation
- Internal ALE and 3rd Generation ALE
- Internal High Speed Modem
- Internal Type I Encryption
- Internal Digital Voice
- 26.6 VDC Operation

See page 14 for
Antenna Couplers



See page 15 for
Antennas



See page 25 for
Accessories



See page 32 for
Frequently Asked
Questions



125-Watt Systems

RF-5800H-V004 Vehicular System



Specifications

- 125-watt PEP/Average
- 1.6 to 30 MHz
- Internal ALE and 3rd Generation ALE
- Internal High Speed Modem Waveforms
- Internal Type I Encryption
- Internal Digital Voice
- 26.5 VDC Operation

*AN/PRC-150(C)
Not Included,
Order Separately*

RF-5800H-B004 Base Station System

Specifications

- 125-watt PEP/Average
- 1.6 to 30 MHz
- Internal ALE and 3rd Generation ALE
- Internal High Speed Modem Waveforms
- Internal Type I Encryption
- Internal Digital Voice
- 115/230 VAC Operation

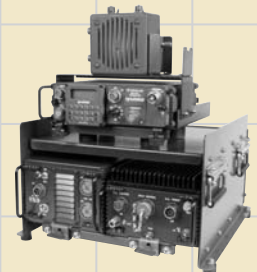

*AN/PRC-150(C)
Not Included,
Order Separately*

RF-5800H-TM004 Transit Case System

Specifications

- 125-watt PEP/Average
- 1.6 to 30 MHz
- Internal ALE and 3rd Generation ALE
- Internal High Speed Modem Waveforms
- Internal Type I Encryption
- Internal Digital Voice
- 115/230 VAC Operation

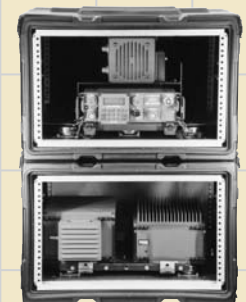

*AN/PRC-150(C)
Not Included,
Order Separately*

RF-5800H-V001, RF-5800H-V002, Vehicular System

Specifications

- 150-watt PEP/Average
- 1.6 to 30 MHz
- 30 to 60 MHz FM Operation
- Internal ALE and 3rd Generation ALE
- Internal High Speed Modem Waveforms
- Internal Type I Encryption
- Internal Digital Voice
- 26.5 VDC Operation
- RF-5800H-V002 includes Collocation Filtering and Internal Pre/postselector



*AN/PRC-150(C)
Not Included,
Order Separately*

RF-5800H-B001, RF-5800H-B002 Base Station System

Specifications

- 150-watt PEP/Average
- 1.6 to 30 MHz
- 30 to 60 MHz FM Operation
- Internal ALE and 3rd Generation ALE
- Internal High Speed Modem Waveforms
- Internal Type I Encryption
- Internal Digital Voice
- 115/230 VAC Operation
- RF-5800H-B002 includes Collocation Filtering and Internal Pre/Postselector



*AN/PRC-150(C)
Not Included,
Order Separately*

RF-5800H-TM001, RF-5800H-TM002 Transit Case System

Specifications

- 150-watt PEP/Average
- 1.6 to 30 MHz
- 30 to 60 MHz FM Operation
- Internal ALE and 3rd Generation ALE
- Internal High Speed Modem Waveforms
- Internal Type I Encryption
- Internal Digital Voice
- 115/230 VAC Operation
- RF-5800H-TM002 includes Collocation Filtering and Internal Pre/Postselector

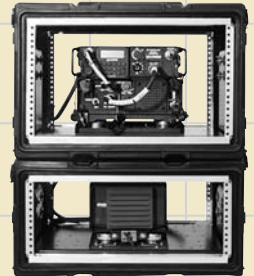

*AN/PRC-150(C)
Not Included,
Order Separately*

See page 14 for
Antenna Couplers



See page 15 for
Antennas



See page 25 for
Accessories



See page 32 for
Frequently Asked
Questions



AN/PRC-150(C) Radio System

400-Watt System

RF-5800H-V003 Vehicular System



Specifications

- 400-watt PEP/Average
- 1.6 to 30 MHz
- Internal ALE and 3rd Generation ALE
- Internal High Speed Modem Waveforms
- Internal Type I Encryption
- Internal Digital Voice
- 26.5 VDC Operation

*AN/PRC-150(C)
Not Included,
Order Separately*

See page 14 for
Antenna Couplers



See page 15 for
Antennas



See page 25 for
Accessories



See page 32 for
Frequently Asked
Questions



RF-5800H-B003 Base Station System

Specifications

- 400-watt PEP/Average
- 1.6 to 30 MHz
- Internal ALE and 3rd Generation ALE
- Internal High Speed Modem Waveforms
- Internal Type I Encryption
- Internal Digital Voice
- 115/230 VAC Operation

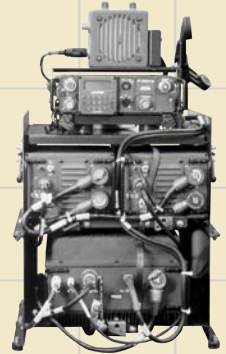

*AN/PRC-150(C)
Not Included,
Order Separately*

RF-5800H-TM003 Transit Case System

Specifications

- 400-watt PEP/Average
- 1.6 to 30 MHz
- Internal ALE and 3rd Generation ALE
- Internal High Speed Modem Waveforms
- Internal Type I Encryption
- Internal Digital Voice
- 115/230 VAC Operation



*AN/PRC-150(C)
Not Included,
Order Separately*

Nomenclature Systems

AN/VRC-104(V)1 20-Watt Vehicular System



*AN/PRC-150(C)
Not Included,
Order Separately*

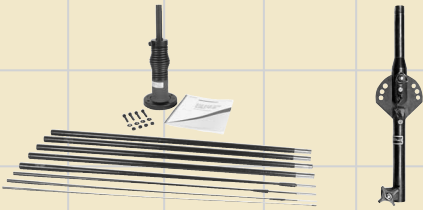

Specifications

- 20-watt PEP/ Average
- 1.6 to 30 MHz
- 30 to 60 MHz FM Operation
- Internal ALE and 3rd Generation ALE
- Internal High Speed Modem
- Internal Type I Encryption
- Internal Digital Voice
- 26.6 VDC Operation
- See System Interconnect Diagrams for equipment list

See page 14 for
Antenna Couplers



See page 15 for
Antennas



See page 25 for
Accessories



See page 32 for
Frequently Asked
Questions



AN/VRC-104(V)2 20-Watt Vehicular System



*AN/PRC-150(C)
Not Included,
Order Separately*

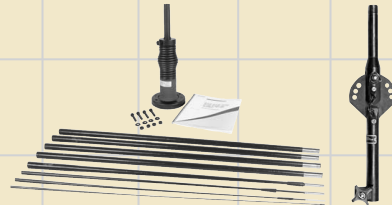

Specifications

- 20-watt PEP/ Average
- 1.6 to 30 MHz
- 30 to 60 MHz FM Operation
- Internal ALE and 3rd Generation ALE
- Internal High Speed Modem
- Internal Type I Encryption
- Internal Digital Voice
- 26.6 VDC Operation
- See System Interconnect Diagrams for equipment list

AN/VRC-104(V)3 150-Watt Vehicular System

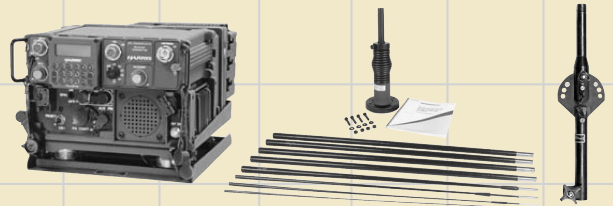

*AN/PRC-150(C)
Not Included,
Order Separately*

Specifications

- 150-watt PEP/ Average
- 1.6 to 30 MHz
- 30 to 60 MHz FM Operation
- Internal ALE and 3rd Generation ALE
- Internal High Speed Modem
- Internal Type I Encryption
- Internal Digital Voice
- 26.6 VDC Operation
- See System Interconnect Diagrams for equipment list

AN/PRC-150(C) Radio System

Nomenclature System Interconnect Diagrams

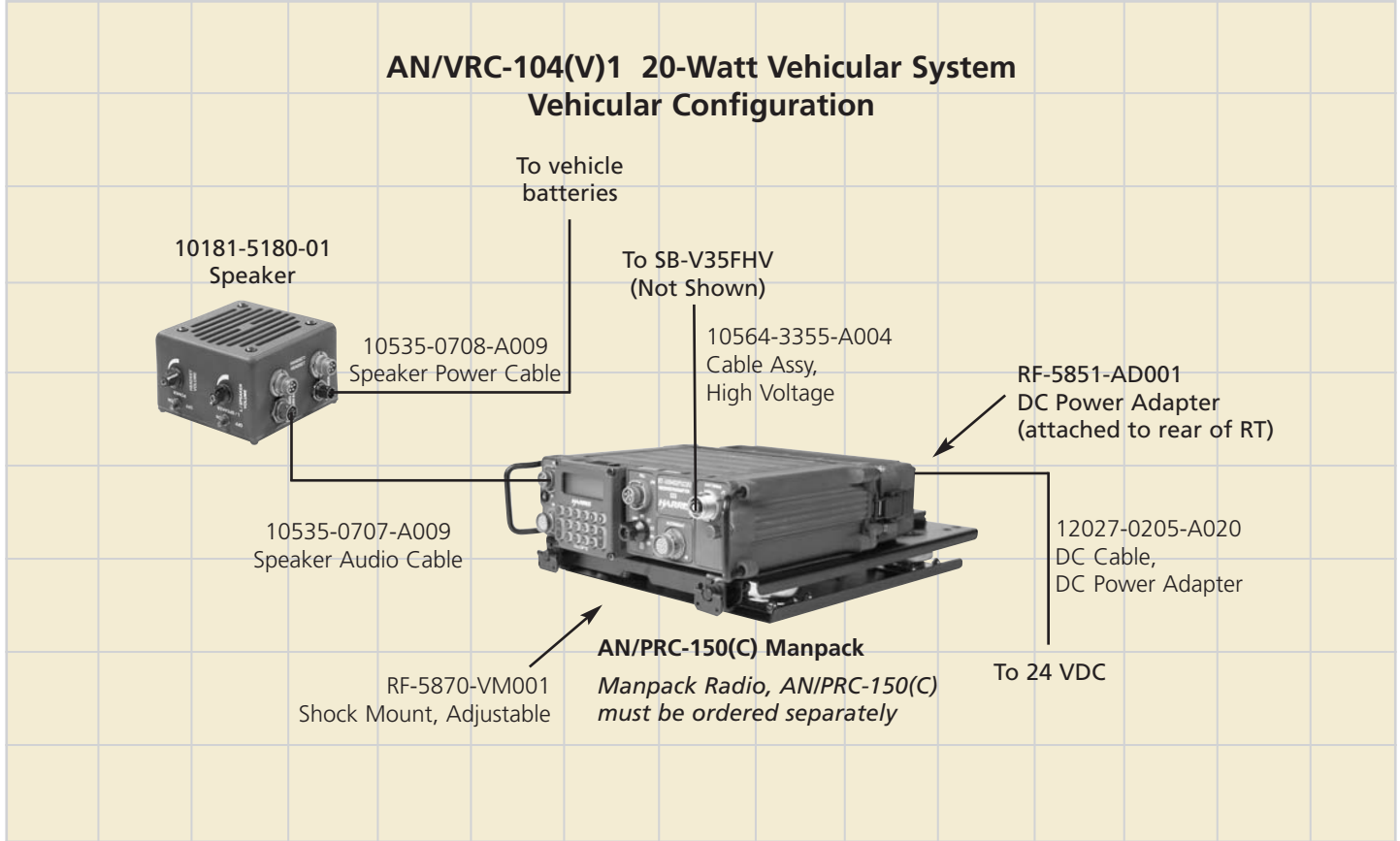

PARTS LIST

RF-5851-AD001	DC Filter
RF-5870-VM001	Radio Shock Mount
RF-5870-VM002	Security Lock
12027-0205-A020	DC Power Cable (20 foot)
10181-5180-01	External Speaker
10535-0707-A009	AN/PRC-150(C) to Speaker Cable (9 foot)
10535-0708-A009	Speaker DC Power Cable (9 foot)
SB-V35FHV	35-Foot Whip Antenna
RF-1980-AT001	Tilt Whip Antenna Adapter

Nomenclature System Interconnect Diagrams

AN/VRC-104(V)2 20-Watt Vehicular System Vehicular Configuration

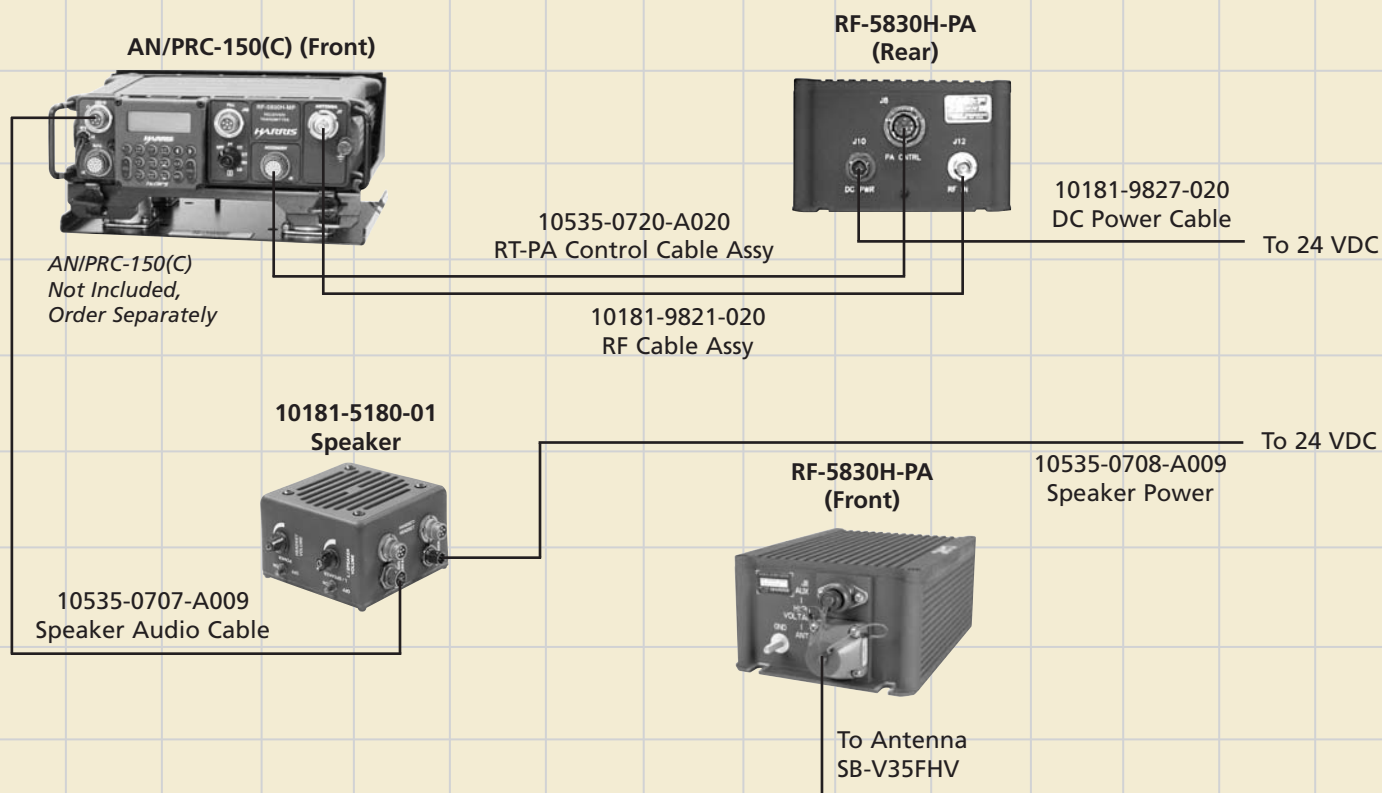

PARTS LIST

RF-5830H-PA001	20-Watt Power Amplifier / Antenna Coupler
10535-0720-A020	AN/PRC-150(C) to RF-5830H-PA001 Control Cable (20 feet)
10181-9821-020	AN/PRC-150(C) to RF-5830H-PA001 Coax Cable (20 feet)
RF-5211VSM	Radio Shock Mount
10372-0874-01	Security Locking Kit
10181-9827-020	DC Power Cable (20 foot)
10181-5180-01	External Speaker
10535-0707-A009	AN/PRC-150(C) to Speaker Audio Cable (9 feet)
10535-0708-A009	Speaker DC Power Cable (9 feet)
SB-V35FHV	35-Foot Whip Antenna
RF-1980-AT001	Tilt Whip Antenna Adapter

AN/PRC-150(C) Radio System

Nomenclature System Interconnect Diagrams

AN/VRC-104(V)3 150-Watt System Interconnect Diagram Vehicular Configuration

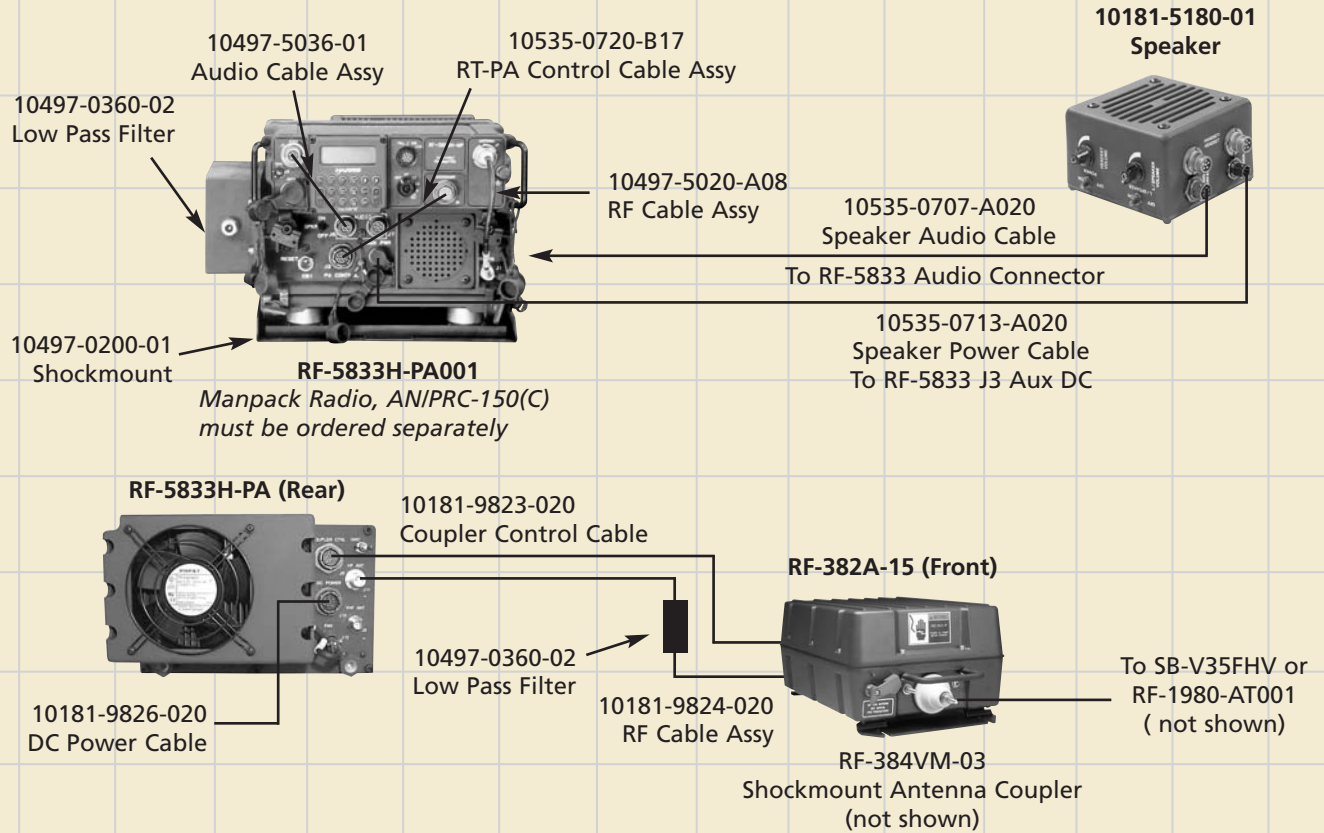

PARTS LIST

RF-5833H-PA001	150-Watt Power Amplifier
10497-0360-02	Collocation Filter
10497-5036-01	AN/PRC-150(C) to RF-5833H-PA001 Audio Cable
10535-0720-B17	AN/PRC-150(C) to RF-5833H-PA001 Control Cable
10497-5020-A08	AN/PRC-150(C) to RF-5833H-PA001 Coax Cable
10497-0200-01	Shock Mount
10497-0870-01	PA Locking Kit
10181-9826-020	DC Power Cable (20 feet)
10181-5180-01	External Speaker
10535-0707-A020	RF-5833H-PA001 to Speaker Audio Cable (20 feet)
10535-0713-A020	RF-5833H-PA001 to Speaker Audio DC Power Cable (20 feet)
RF-382A-15	Antenna Coupler
RF-384VM-03	Antenna Coupler Shock Mount
10181-9823-020	Antenna Coupler Control Cable (20 feet)
10181-9824-020	Antenna Coupler Coax Cable (20 feet)
SB-V35FHV	35-Foot Whip Antenna
RF-1980-AT001	Tilt Whip Antenna Adapter

Nomenclature Systems

AN/TRC-209 150-Watt Transit Station System



*AN/PRC-150(C)
Not Included,
Order Separately*

Specifications

- 150-watt PEP/ Average
- 1.6 to 30 MHz
- 30 to 60 MHz FM Operation
- Internal ALE and 3rd Generation ALE
- Internal High Speed Modem
- Internal Type I Encryption
- Internal Digital Voice
- 115 / 230 VAC Operation

See page 14 for
Antenna Couplers



See page 15 for
Antennas



See page 25 for
Accessories



See page 31 for
Frequently Asked
Questions



AN/TRC-210(V)2 400-Watt Transit Case System

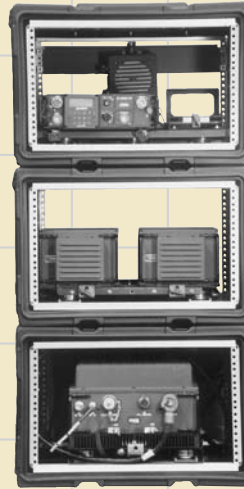

*AN/PRC-150(C)
Not Included,
Order Separately*

Specifications

- 400-watt PEP/ Average
- 1.6 to 30 MHz
- Internal ALE and 3rd Generation ALE
- Internal High Speed Modem
- Internal Type I Encryption
- Internal Digital Voice
- 115 / 230 VAC Operation

AN/PRC-150(C) Radio System

Nomenclature System Interconnect Diagrams

AN/TRC-209 150-Watt System Transit Case System Interconnect Diagram

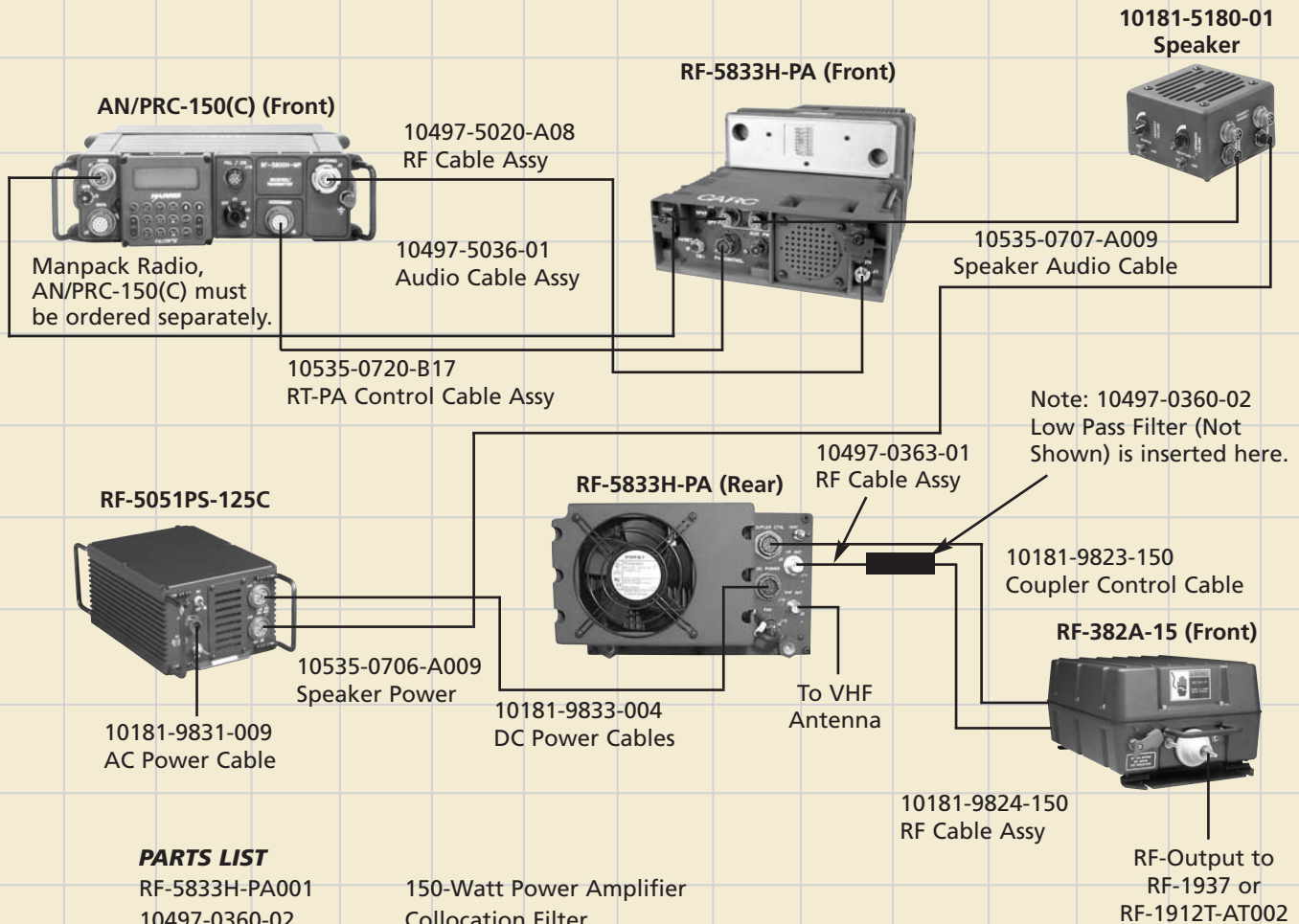

PARTS LIST

RF-5833H-PA001	150-Watt Power Amplifier
10497-0360-02	Collocation Filter
10497-5036-01	AN/PRC-150(C) to RF-5833H-PA001 Audio Cable
10535-0720-B17	AN/PRC-150(C) to RF-5833H-PA001 Control Cable
10497-5020-A08	AN/PRC-150(C) to RF-5833H-PA001 Coax Cable
10497-0870-01	PA Locking Kit
RF-5051PS-125C	Power Supply
10181-9831-009	AC Power Cable (9 feet)
10181-5180-01	External Speaker
10535-0707-A009	RF-5833H-PA001 to Speaker Audio Cable (9 feet)
10535-0706-A009	RF-5051PS-125C to Speaker DC Power Cable (9 feet)
RF-382A-15	Antenna Coupler,
10540-0510-01	Antenna Coupler Cables on Cable Reel (150 feet each)
RF-1912T-AT002	Transportable Dipole Antenna
10251-0030	RF-1937 Antenna Kit

Nomenclature System Interconnect Diagrams

AN/TRC-210(V)2 400-Watt Transit Case System Interconnect Diagram

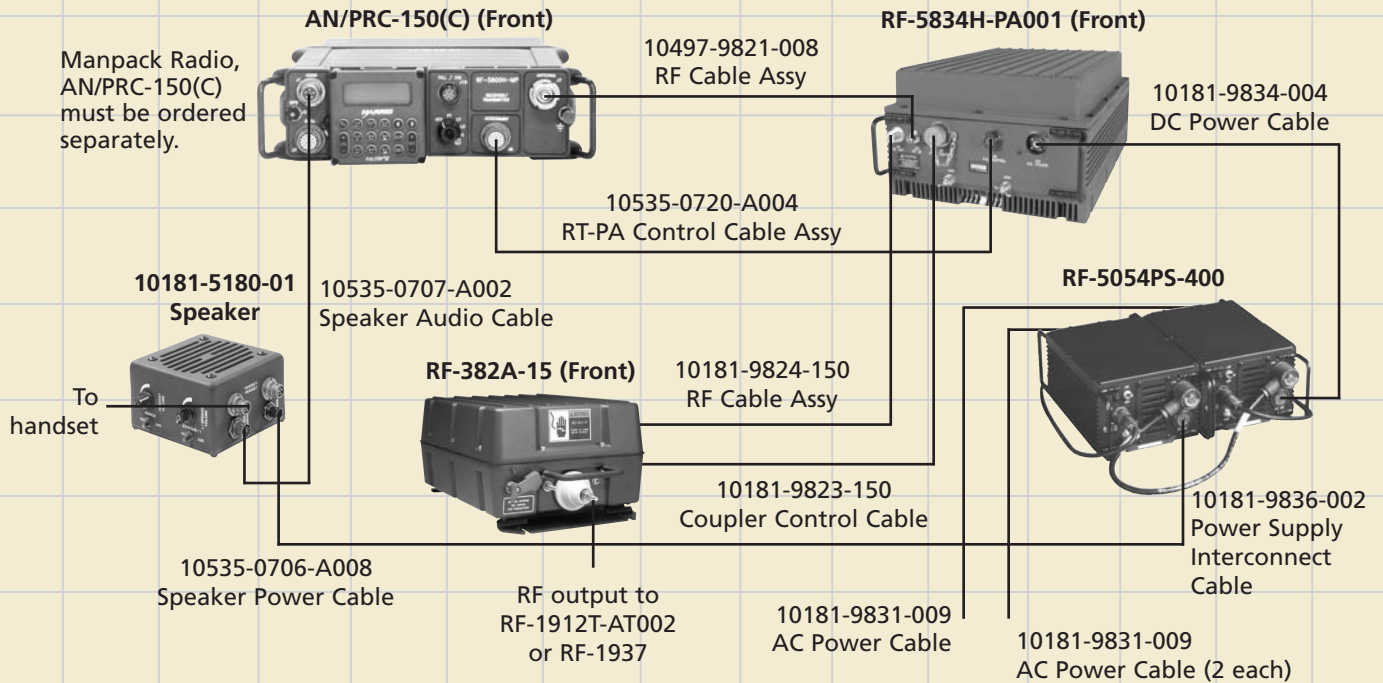

PARTS LIST

11040-1100-01	AN/PRC-150(C) Transit Case (without AN/PRC-150(C) manpack)
■ 10181-5180-01	External Speaker
■ 10535-0707-A002	RF-5834H-PA001 to Speaker Audio Cable (2 feet)
■ 10535-0706-A008	RF-5054PS-400 to Speaker DC Power Cable (8 feet)
■ 10181-9821-008	AN/PRC-150(C) to RF-5834H-PA001 Coax Cable
■ 10535-0720-A008	AN/PRC-150(C) to RF-5834H-PA001 Control Cable
10400-0561-17	Amplifier Transit Case
■ RF-5834H-PA001	400-Watt Power Amplifier
■ 10181-9834-004	DC Power Cable, Amp to PS (4 feet)
10400-0561-16	Power Supply Transit Case
■ RF-5054PS-400	Power Supply
■ 10181-9831-009	AC Power Cable, 2 each (9 feet)
■ 10181-9836-002	Power Supply Interconnect Cable
10564-1720-05	Collocation Filter
10400-0561-14	Antenna Coupler Transit Case (without Antenna Coupler)
RF-382A-15	Antenna Coupler
10540-0510-01	Antenna Coupler Cables on Cable Reel
■ 10181-9823-150	Antenna Coupler Control Cable (150 feet)
■ 10181-9824-150	Antenna Coupler Coax Cable (150 feet)
RF-1912T-AT002	Transportable Dipole Antenna
10251-0030	RF-1937 Antenna Kit
10515-0123-4200	Installation Manual

Antenna Couplers

RF-5382-CU001
125-Watt/150-Watt Antenna Coupler



RF-382A-15
400-Watt Antenna Coupler



RF-5382H-TM001 150-Watt Antenna Coupler Mini-Transit Case System



- Includes 250-foot Control Cable and 250-foot Coax Cable

RF-382A-15TM 400-Watt Antenna Coupler Mini-Transit Case System



- Includes 250-foot Control Cable and 250-foot Coax Cable

Definitions

Choosing the correct antenna for a particular application is contingent on a number of factors such as:

- **where** the antenna is configured and mounted (on the ground, vehicular, etc.)
- **how** much power is being used
- **the distance** to the receiving station

Using HF to communicate over long distances relies on the ionosphere, a region of electrically charged particles in the earth's atmosphere, extending from approximately 50 to 600 km above the earth's surface. The ionosphere makes long distance HF radio communications possible. When radio waves from a radio strike these ionized layers, depending on the frequency, they are refracted so that they return to the earth. The angle at which the radio waves strike and are refracted back determines the range of communications. Distances for HF communication are generally broken down into the following areas:

- **Groundwave** – 0 to 80 km
- **Near Vertical Incident Skywave (NVIS)** – 0 to 500 km
- **Medium Range** – 500 to 2000 km
- **Long Range** – 2000 km or greater

The type of antenna and how it's configured will determine how it radiates, resulting in how far it can be used to communicate. Below is a list of some common type of antennas:

Vertical Whip Antennas – Whip antennas are useful for ground wave communications as well as long range communications. These antennas radiate well in all directions. Some vehicular mounted whips can be used for NVIS communications if they are tilted using a tilt adapter.

Dipole Antennas – Dipole antennas are wire antennas strung between two poles or supports and the center connected to the radio. They are useful for medium range or NVIS communications. Dipoles tend to radiate in a mostly bi-directional pattern – broadside to the antenna.

Inverted "V" Antenna – Inverted "V" antennas are a version of a wire dipole antenna that uses a single center support. The ends are brought down from the center support in a "V" shape at about a 90° angle, but in line with the center. It is useful for medium range communications. Like dipoles, Inverted "V" antennas tend to radiate in a mostly bi-directional pattern – broadside to the antenna.

Sloping "V" Antenna – The Sloping "V" antenna uses a single center support and the ends are brought down, sloping at a low angle away from the center support. Narrowing the angle between the sloping ends from 60 degrees to 30 degrees increases the antenna's range from medium range to long range respectively. Adding terminating resistors to the ends of the wires makes the Sloping "V" antenna a directional antenna, radiating the signal in the direction of the sloping wires.

Long Wire Antenna – The Long Wire Antenna is just what the name implies. It's a long piece of wire connected to the radio. Typically long wire antennas are used for medium to long range communications. The longer the wire, the longer the range of the antenna. Long Wire antennas tend to radiate in a mostly bi-directional pattern – broadside to the antenna.

NVIS Antenna - This antenna is also useful in applications where terrain features like mountains are in between stations, effectively blocking groundwave communications. The antenna is designed to radiate mostly straight up, resulting in the signal to be refracted back within 0 to 500 km to the transmitting site, but clearing terrain features. NVIS antennas, for the most part, radiate well in all directions.

The system output power will also have an effect on the distance. A 20-watt manpack provides groundwave and medium range distances. 125- and 150-watt systems provide medium range and "shorter" long range distances. A 400-watt system will provide long range distances.

Antenna type and configuration, power and mounting, all factor into which antenna should be used. The following charts can be used to select the proper Harris antenna for an application based on the radio configuration: manpack, vehicular, and transportable/fixed mounting for varying distances.

Note: Most of these antennas require an antenna coupler if used in any configuration other than a manpack. Refer to the individual antenna descriptions to determine if an antenna coupler is needed.

Antennas

Whip Antenna Selection Chart

MODEL NUMBER	TYPE	APPLICATION			
		GROUNDWAVE	NVIS 0 to 500 km	MEDIUM RANGE 500 to 2000 km	LONG RANGE 2000 km or greater
10372-0240-02	Manpack	X			
RF-1937	Transportable	X			X
SB-V16C	Stationary Fixed	X	X *		X
SB-V16B	Vehicular	X	X *		X
SB-V16FHD	Vehicular	X	X *		
SB-V16T	Vehicular (Metal)	X			
SB-V35C	Stationary Transportable	X	X *		X
SB-V35B	Vehicular	X	X *		X
SB-V35FHV	Vehicular	X	X *		X
SB-V35S	Fixed or Shipboard	X			X
RF-1980F-AT003	Vehicular	X	X		
RF-1942-AT001	Vehicular (whip configuration)	X	X **		X

NOTES:

* When used with RF-1980-AT001 Tilt Whip Adapter.

** When used in tilt whip configuration.

Wire Antenna Selection Chart

MODEL NUMBER	TYPE NUMBER	DESCRIPTION	APPLICATION			
			GROUNDWAVE	NVIS 0 to 500 km	MEDIUM RANGE 500 to 2000 km	LONG RANGE 2000 km or greater
RF-1940-AT001	Manportable	Dipole	X *	X *	X *	X *
RF-1941	Manportable	Dipole	X *	X *	X *	X *
SB-A150	Manportable	Long Wire	X			X
RF-1942-AT001	Transportable (wire configuration)	Inverted "V"	X	X	X	
RF-1944-AT150	Transportable	Inverted "V"		X	X	
RF-1944-AT400	Transportable	Inverted "V"		X	X	
RF-1912T-AT002	Transportable	Dipole	X **	X	X	X **
RF-1912B-AT001	Fixed Installation	Dipole	X **	X	X	X **
RF-1912E-AT001	Radiating Element only	Dipole	X **	X	X	X **
RF-1950-AT001	Fixed Installation	Inverted "V"		X	X	
RF-1936P-10	Manportable	Crossed Dipole		X	X	
RF-1936V-10	Vehicular	Crossed Dipole		X	X	
RF-1938AT-10	Portable Freestanding or Vehicular	Crossed Dipole		X	X	

NOTES:

* The RF-1940-AT001 and RF-1941 antennas can be used in many different configurations providing different range capabilities.

** When configured as a top-loaded monopole.

10372-0240-01

Manpack HF/VHF Whip Antenna Kit



The 10372-0240-01 is a collapsible whip antenna kit for the AN/PRC-150(C) Manpack (one is supplied with each manpack). The antenna is capable of 20-watt operation from 2-60 MHz, providing ground wave communications. The antenna is automatically tuned by the radios internal coupler. The kit includes:

AT271A/PRC-25	Collapsible Whip Antenna
AB-591/PRC-25	Flexible Base
10372-1215-01	Base Adapter
10372-0249-01	Antenna Bag

RF-1940-AT001

Portable HF Dipole Antenna



The RF-1940-AT001 is a lightweight, portable dipole antenna. The antenna is capable of 400-watt maximum operation from 3-30 MHz. It can be configured in many different configurations (dipole, sloping dipole, or a sloping V) providing different range capabilities. The antenna is stored on self-contained flat spools, with throwing weights for connection to trees, buildings, or masts. The RF-1940-AT001 can be directly connected to the AN/ PRC-150(C) manpack using the built-in antenna coupler or connected to an external antenna coupler. The antenna includes a carrying bag, a 33-foot RG-58 coax cable with BNC male connectors, and a BNC to Type N adapter.

Deployed size:	150 feet (45.7m)
Transport size:	6" x 12" x 3" (15cm x 30cm x 7cm)
Weight:	5 lbs. (2.3 kg)

RF-1941

Portable HF Dipole Antenna

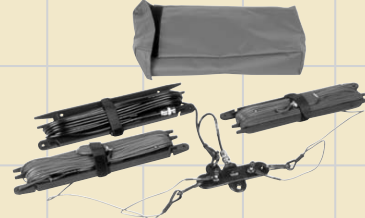

The RF-1941 is a lightweight, portable dipole antenna capable of 400-watt maximum operation from 2-30 MHz. It can be configured as a dipole, sloping dipole, or a sloping V (providing different range capabilities). The antenna is stored on self-contained flat spools, with throwing weights for connection to trees, buildings, or masts. The RF-1941 can be directly connected to the AN/PRC-150(C) manpack using the built-in antenna coupler or connected to an external antenna coupler. The antenna includes a carrying bag, a 33-foot RG-58 coax cable with BNC male connectors, and a BNC to Type N adapter.

Deployed size:	250 feet (76.2m)
Transport size:	6" x 12" x 3" (15cm x 30cm x 7cm)
Weight:	5 lbs. (2.3 kg)

RF-1944-AT150

Transportable HF Broadband - Inverted V Antenna



The RF-1944-AT150 is a low profile, lightweight, tactical broadband dipole antenna for operation in an inverted-V configuration, utilized for NVIS communications. The antenna is capable of 150 watt maximum operation from 1.6-30 MHz. The RF-1944-AT150 antenna provides broadband performance over the entire frequency range without an antenna coupler. This antenna is an excellent choice when operating in ALE or ECCM modes in applications where an antenna coupler is not practical. The antenna is comprised of a balun, dipole elements, termination resistors, 33-foot coaxial cable and halyard, and stows into a small canvas bag.

Deployed size:	164 ft. (50 m)
Transport size:	12" x 20" x 3" (30cm x 51cm x 7cm)
Weight:	11 lbs. (5 kg)

RF-1936P-10

Portable HF Crossed Dipole Antenna



The RF-1936P-10 is a rapid-deployment crossed dipole antenna designed specifically for NVIS communications. The antenna is capable of 400-watt maximum operation from 2-30 MHz and requires an antenna coupler. The RF-1936P-10 antenna is designed for free-standing operation when erected on the ground or on flat surfaces and can be erected by two people in five minutes.

Deployed size:
61'L x 61'W x 15'H (18.6m x 18.6m x 4.6m)

Transport size:
7" diameter x 26" (19cm diameter x 65cm)

Weight:
15 lbs. (6.8 kg)

RF-1937

Transportable HF Ground Stake Antenna Kit

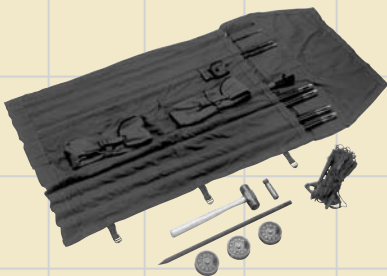

The RF-1937 is a vertically erected, ground stake antenna designed around the SB Series whip antennas. The antenna is capable of 1-kW maximum operation from 2-30 MHz and requires the use of an antenna coupler. The antenna is intended to be used for groundwave or long range communications. It can be set up with whip heights between 16 feet and 32 feet. The RF-1937 is designed for ground level mounting. The base mount is installed on a base stake driven into the ground. The kit includes a guy rope assembly for semi-permanent installations and four ground radials on reels for improved performance.

SB-A150

HF Long Wire Antenna Kit

The SB-A150 includes all materials required to construct a 150-foot long-wire antenna. The antenna is capable of 1-kW maximum operation from 1.6 to 30 MHz. The antenna is intended to be used for groundwave or long range communications. The antenna can be cut to a specific frequency for single channel operation or used with an antenna coupler for broadband operation. The SB-A150 kit includes: ground rod, insulators, wire, and nylon braided support rope.

Deployed size: Up to 150 ft.

Transport size: 6 ft ground rod with wire spool

Weight: 5 lbs. (2.3 kg)

SB-V16B

Feed-through Base 16-Foot HF Whip Antenna

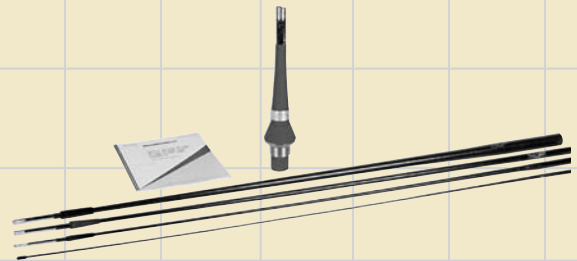

The SB-V16B is a self-supporting fiberglass whip antenna with a feed-through base that is easily assembled and erected. The antenna is capable of 1-kW maximum operation from 2-30 MHz and requires the use of an antenna coupler. The antenna radiates well in all directions and is intended for groundwave communications. The antenna consists of a feed-through base, four 4-foot sections extending to a height of 16 feet. The SB-V16B mounts directly to the RF-292-01 Mounting Base for vehicular application. The RF-292-01 must be ordered separately.

Deployed size: 16 ft (4.8 m)

Weight: 5 lbs. (2.3 kg)

SB-V16C

Flange Base 16-Foot HF Whip Antenna

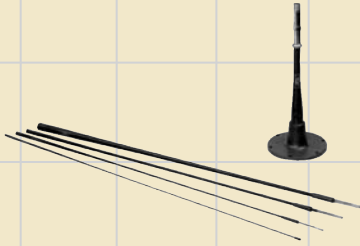

The SB-V16C is a self supporting fiberglass whip antenna with a flange base that is easily assembled and erected. The antenna is capable of 1-kW maximum operation from 2-30 MHz and the antenna requires the use of an antenna coupler. The antenna radiates well in all directions and is intended for groundwave communications. The antenna consists of a flange base, four tapered 4-foot sections extending to a height of 16 feet. The SB-V16C has a flange base designed for stationary applications.

Deployed size: 16 ft (4.8 m)

Weight: 9 lbs. (4.1 kg)

SB-V16FHD

Spring Base 16-Foot HF Whip Antenna

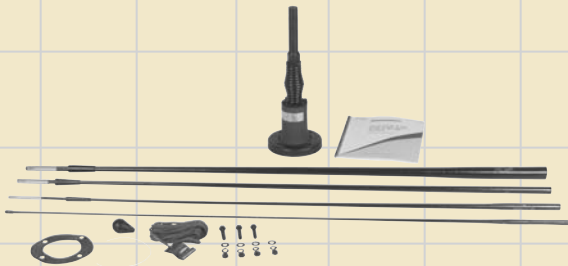

The SB-V16F is a self-supporting fiberglass whip antenna with a spring base that is easily assembled and erected. The antenna is capable of 1-kW maximum operation from 2-30 MHz and requires the use of an antenna coupler. The antenna radiates well in all directions and is intended for groundwave communications. The antenna consists of a spring base, four tapered 4-foot sections extending to a height of 16 feet. The SB-V16F mounts directly to the RF-292-01 Mounting Base for vehicular application. The RF-292-01 must be ordered separately.

Deployed size: 16 ft (4.8 m)

Weight: 14 lbs. (6.4 kg)

SB-V16T

Self Supporting 16-Foot HF Whip Antenna

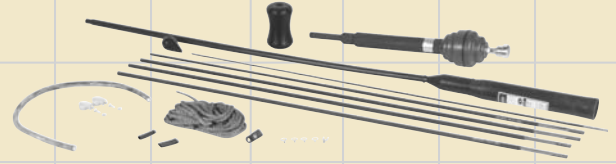

The SB-V16T is a coated metal whip antenna that is easily assembled and erected. The antenna is capable of 400-watt maximum operation from 2-30 MHz and requires the use of an antenna coupler. The antenna radiates well in all directions and is intended for groundwave communications. The antenna consists of a feed-through base, four 4-foot metallic sections extending to a height of 16 feet. The SB-V16T also contains an adapter plate and mounting hardware to permit mounting to a RF-292-01 Mounting Base. The RF-292-01 must be ordered separately. The SB-V16T is not compatible with the RF-1980 Tilt Whip Adapter.

Deployed size: 16 ft (4.8 m)

Weight: 5 lbs. (2.3 kg)

RF-1980F-AT003

Spring Base 16-Foot HF Tilt Whip Antenna

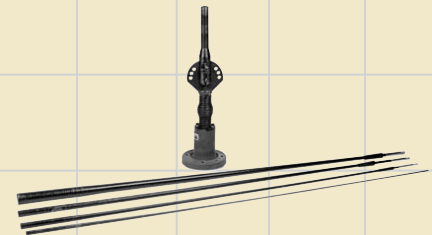

The RF-1980-AT003 is a self-supporting fiberglass whip antenna that is easily assembled and erected. The antenna is capable of 1kW maximum operation from 2-30 MHz and requires the use of an antenna coupler. The antenna radiates well in all directions and is intended for groundwave communications or can be tilted over for NVIS communication. The antenna consists of spring base and four tapered 4-foot sections extending to a height of 16 feet, and a tilt whip adapter. The tilt adapter mechanism allows the antenna to tilt at 0° (vertical), 50°, 70°, and 90° (horizontal). This unique capability allows a groundwave whip to tilt over and become ideal for NVIS communications on the move. The RF-1980F-AT003 bolts directly to the RF-292-01 Mounting Base for vehicular application. The RF-292-01 must be ordered separately.

Deployed size: 16 ft (4.8 m)

Weight: 25 lbs. (11.3 kg)

SB-V35B

Feed-through Base 32-Foot HF Whip Antenna

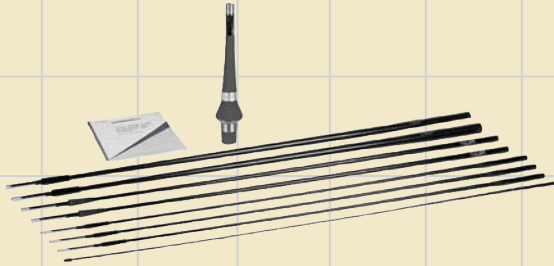

The SB-V35B is a self-supporting fiberglass whip antenna with a feed-through base that is easily assembled and erected. The antenna is capable of 1-kW maximum operation from 2-30 MHz and requires the use of an antenna coupler. The antenna radiates well in all directions and is intended for groundwave communications. The antenna consists of a feed-through base, four straight and four tapered 4-foot sections extending to a height of 32.5 feet. The SB-V35B mounts directly to the RF-292-01 Mounting Base for vehicular application. The RF-292-01 must be ordered separately.

Deployed size: 32.5 ft (10 m)

Weight: 11 lbs. (5 kg)

SB-V35C

Flange Base 32-Foot HF Whip Antenna

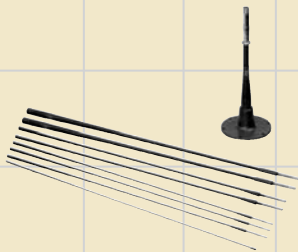

The SB-V35C is a self-supporting fiberglass whip antenna with a flange base that is easily assembled and erected. It is self-supporting, but may be guyed. The antenna is capable of 1-kW maximum operation from 2-30 MHz and the antenna requires the use of an antenna coupler. The antenna radiates well in all directions and is intended for groundwave communications. The antenna consists of a flange base, four tapered 4-foot sections extending to a height of 32.5 feet. The SB-V35C has a flange base designed for stationary applications.

Deployed size: 32.5 ft (10 m)

Weight: 15 lbs. (6.8 kg)

SB-V35FHV

Locking Spring Base 32-Foot HF Whip Antenna

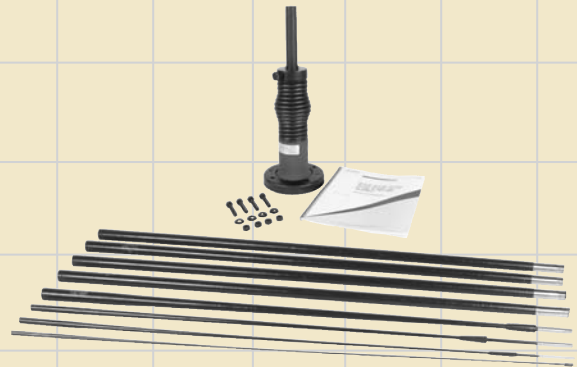

The SB-V35F is a self-supporting fiberglass whip antenna with a locking spring base that is easily assembled and erected. The antenna is capable of 1-kW maximum operation from 2-30 MHz and requires the use of an antenna coupler. The antenna radiates well in all directions and is intended for groundwave communications. The antenna consists of a spring base, four straight and four 4-foot sections extending to a height of 32.5 feet. The spring base permits the flexible spring to be locked in either a rigid vertical position (stationary operations) or left in a flexible mode (mobile or NVIS operations). The SB-V35F mounts directly to the RF-292-01 Mounting Base for vehicular application. The RF-292-01 must be ordered separately.

Deployed size: 32.5 ft (10 m)

Weight: 20 lbs. (9.1 kg)

SB-V35S

Shipboard Flange Base 35-Foot HF Whip Antenna

The SB-V35S is a heavy-duty fiberglass whip antenna with a flange base intended for shipboard or stationary use. The antenna is capable of 5-kW maximum operation from 2-30 MHz and requires the use of an antenna coupler. The antenna radiates well in all directions and is intended for groundwave communications. The antenna consists of a flange base, two sections extending to a height of 35 feet. The SB-V35S is not compatible with the RF-1980 Tilt Whip Adapter.

Deployed size: 35 ft (11 m)

Weight: 65 lbs. (30 kg)

RF-1936V-10

Portable Vehicle Mounted HF Crossed Dipole Antenna



The RF-1936V-10 is a portable vehicle mounted crossed dipole antenna designed for NVIS communications. The antenna is capable of 400-watt maximum operation from 2-30 MHz and requires an antenna coupler. This antenna is easy to carry and can be erected by two people in five minutes. The RF-1936V-10 is used in conjunction with the mounting bases of the SB-V16B/C/F or SB-V35B/C/F series of fiberglass whip antennas to provide improved operation when the vehicle is in a fixed, temporary location. This antenna can also be used with an RF-5351 Siting Kit. The RF-1936V-10 is not compatible with the SB-V16T, SB-V35S, or RF-1930CHD bases.

Deployed size: 61'L x 61'W x 15' H (18.3 m x 18.3 m x 4.5 m)
 Transport size: 7" diameter x 26" (18 cm diameter x 65 cm)
 Weight: 15 lbs. (6.8 kg)

RF-1942-AT001

HF Vehicular Antenna Kit

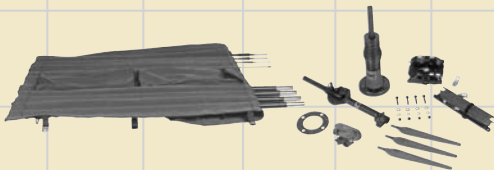

The RF-1942-AT001 HF antenna kit includes all accessories for quick deployment of mobile and stationary configurations. The antenna is capable of 1-kW maximum operation from 2-30 MHz and requires use of an antenna coupler. The RF-1942-AT001 is a combination of antennas that can be configured into:

- 32 foot whip for exceptionally efficient groundwave and long range communications
- 16 foot tilt whip for on-the-move NVIS communications
- Inverted V for enhanced long range performance

The RF-1942-AT001 includes whip sections, wire elements, and tilt whip adapter stowed in a canvas bag for transportability. The RF-292-01 Antenna Mount can be used to mount the antenna to a vertical surface. The RF-292-01 must be ordered separately.

Deployed size: (Inverted V): 16.4'H x 72'W (5m x 22m)
 Weight: 37 lbs. (16.8kg)

RF-1912B-AT001

Fixed HF Fan Dipole Antenna



The RF-1912B-AT001 is a fixed installation fan dipole antenna that includes all the components for transporting and permanent installation. It is capable of 1-kW maximum operation from 1.6-30 MHz and requires an antenna coupler. The RF-1912B has been optimized for both NVIS communications between 1.6 and 10 MHz and medium range communications out to 1200 km for 10 to 30 MHz. The element length and height above ground is designed for optimal HF propagation. It can also be configured as a top-loaded monopole for groundwave and long range communications. Included are two black masts, guy assemblies, guy anchors, a pre-constructed radiating element assembly, vertical feedline, antenna coupler baseplate, installation kit, and a spare parts kit.

Deployed size: 105'L x 26'W x 30'H
 (32 m x 8 m x 9 m)

RF-1912E-AT001

HF Fan Dipole Antenna Radiating Element



The RF-1912E-AT001 is a fan dipole antenna radiating element. It is capable of 1-kW maximum operation from 1.6-30 MHz and requires an antenna coupler. The RF-1912E has been optimized for both NVIS communications between 1.6 and 10 MHz and medium range communications out to 1200 km for 10 to 30 MHz. The element length has been designed for optimal HF propagation. It can also be configured as a top loaded monopole for groundwave and long range communications. The antenna includes the radiating elements and 24 feet of vertical feedline. This antenna is supplied with 100 feet of rope to support the RF-1912E-AT001 on customer-supplied masts.

Deployed size: 105'L x 26'W x 30'H
 (32 m x 8 m x 9 m) Typical

Transport size: 18" x 8" x 4" (46 cm x 20 cm x 9 cm)
 Weight: 7 lbs. (3.2 kg)

RF-1912T-AT002

Transportable HF Fan Dipole Antenna



The RF-1912T-AT002 is a transportable fan dipole antenna that includes all the components for transporting and temporary installation. It is capable of 1-kW maximum operation from 1.6-30 MHz and requires an antenna coupler. The RF-1912T has been optimized for both NVIS communications between 1.6 and 10 MHz and medium range communications out to 1200 km for 10 to 30 MHz. The element length and height above ground is designed for optimal HF propagation. It can also be configured as a top-loaded monopole for groundwave and long range communications. The antenna has lightweight aluminum mast sections that are easy to assemble and disassemble. The RF-1912T includes two aluminum masts, guy assemblies, halyards, ground stakes, a pre-constructed radiating element assembly, vertical feedline, and a spare parts kit. All materials are conveniently stored in two storage bags. Storage bags are green, order RF-1912T-AT001 for tan storage bags.

Deployed size: 105'L x 26'W x 30'H (32 m x 8 m x 9 m)
 Transport size: (2 bags) 81" x 11" x 7" and 23" x 14" x 12"
 Weight: 135 lbs. (60 kg)

RF-1938AT-10

Extended Height HF Crossed Dipole Antenna



The RF-1938AT-10 is a rapid-deployment crossed dipole antenna designed for NVIS communications. The antenna is capable of 400-watt maximum operation from 2-30 MHz and requires an antenna coupler. It has an extended height of 8.7 meters to provide up to 10 dB of additional antenna gain at 2 to 4 MHz over the standard RF-1936P-10. It also includes both the RF-1936-01 Antenna Adapter and RF-1936-02 Mounting Plate so that the antenna can be used in portable and vehicular applications.

Deployed size: 61'L x 61'W x 28'H (18.3 m x 18.3 m x 8.6 m)
 Transport size: 2 bags of 7" diameter x 26"
 Weight: 27 lbs. (12.3 kg)

RF-1944-AT400

Transportable HF Broadband-Inverted Vee Antenna



The RF-1944-AT400 is a low-profile, lightweight, tactical broadband dipole antenna for operation in an inverted-V configuration, utilized for NVIS communications. The antenna is capable of 400-watt maximum operation from 1.6 to 30 MHz. The RF-1944-AT400 antenna provides broadband performance over the entire frequency range without use of an antenna coupler. This antenna is an excellent choice when operating in ALE or ECCM modes in applications where an antenna coupler is not practical. The antenna is comprised of a balun, dipole elements, termination resistors, 33-foot coaxial cable, and halyard, and stows into a small canvas bag.

Deployed size: 164 ft. (50 m)
 Transport size: 12" x 20" x 3" (30cm x 51cm x 7cm)
 Weight: 13 lbs. (6 kg)

RF-1950-AT001

Roof Mounted Inverted V HF Dipole Antenna

The RF-1950-AT001 is a roof-mounted inverted V dipole antenna designed to be installed without penetrating the roof. The antenna is capable of 1-kW maximum operation from 2-30 MHz and requires an antenna coupler. The RF-1950-AT001 has been optimized for both NVIS communications between 1.6 and 10 MHz and medium range communications out to 1200 km for 10 to 30 MHz. It incorporates galvanized steel bases and a fiberglass mast to support the antenna elements without penetration of the roof top. One platform holds the fiberglass mast and four small platforms support the guys and elements. The large platform allows direct bolting of the required RF-328A or RF-2601 Antenna Coupler.

Deployed size: 50' L x 33'W x 26' (15m X 10m X 8m)
 Transport size: 83.5" x 21.5" x 17.25" (212cm x 54.6cm x 43.8 cm)
 Weight: 580 lbs with shipping crate

ANTENNA ACCESSORIES

RF-1912T-AT002

Transportable HF Fan Dipole Antenna



RF-1936-01

Vehicular Antenna Adapter for the RF-1936P-10

The RF-1936-01 allows the RF-1936P Series Antennas to be mounted on SB-V16B/C/F or SB-V35B/C/F series antenna bases. (The RF-1936-01 is not usable with SB-V16T, SB-V35S or RF-1930CHD Whip Antenna bases.)

RF-1936-02

Mounting Plate for Flat Surface Mounting for the RF-1936V-10

The RF-1936-02 is a mounting plate that allows RF-1936V series antennas to be erected on the ground or on flat surfaces. It is a part of the RF-1936P antennas.

RF-1980F-AT001

Tilt Whip Adapter, Spring Base

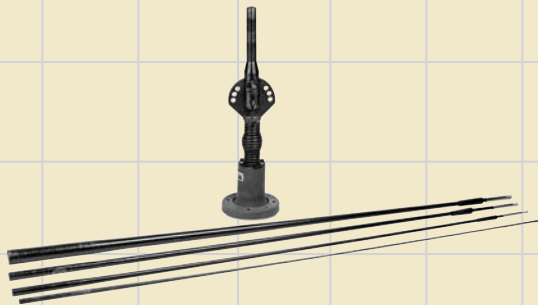

The RF-1980F-AT001 is a tilt mechanism built into a spring base designed for use with the SB-V16 series whip antennas. The RF-1980F-AT001 accepts up to a 16-foot whip antenna and provides the flexibility to tilt from 0° (vertical), 50° 70° and 90°, with locking pin. The RF-1980F-AT001 bolts directly to the RF-292-01 Universal Antenna Mount. Order the RF-292-01 separately.

RF-1980-AT001

Tilt Whip Adapter

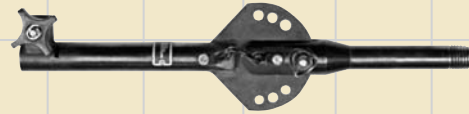

The RF-1980-AT001 is similar to the RF-1980F-AT001 Adapter, except it mounts directly on a standard SB-V16 or SB-V35 whip base. This tilt whip adapter converts a standard SB-V16 or SB-V35 whip antenna base into a tilt whip base. If used with a locking spring base or flange base, a 35-foot whip antenna may be used.

RF-292

Universal Antenna Mount

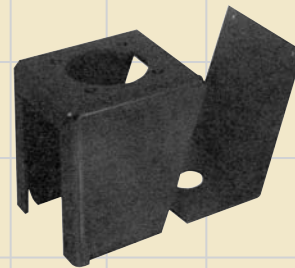

The RF-292 is used to mount antennas to a vehicle, shelter, etc. Mounting hardware is included.

Color: Olive Drab. Order the RF-292-01 for CARC Green 383, RF-292(S) for CARC Forrest Green, RF-292(S)1 for CARC Tan.

DATA AND REMOTE CONTROL CABLES

10511-0707-A006

Generic Audio/Data Cable, Unterminated

A generic audio and data cable that is unterminated on the opposite end. Length is 6 feet.

10535-0770-A006

Sync / Async Data Cable with DB-9 Connector

This cable provides a synchronous or asynchronous connection to the radio. The opposite end utilizes a 9-pin D style connector. Length is 6 feet.

10535-0780-A006

Sync / Async Data Cable with DB-25 Connector

This cable provides a synchronous or asynchronous connection to the radio. The opposite end utilizes a 25-pin D style connector. Length is 6 feet.

10518-1694-A006

Data / Remote Control Y Cable

This cable provides both a synchronous/asynchronous data interface and RS-232 remote control interface to the radio. This is a Y cable that connects to the front panel J3 connector. The opposite end utilizes a 25-pin D style connector for data and a 9-pin D style connector for remote control. Length is 6 feet.

10535-0775-A006

Asynchronous Data (PPP) Cable

This cable provides an asynchronous data connection to the radio using the PPP connection on the front panel connector J3. The opposite end utilizes a 9-pin D style connector. This cable is supplied with every AN/PRC-150(C) radio. Length is 6 feet.

10535-0740-A006

Remote Control / Programming Cable, J6 Accessory Connector

This cable provides remote control and programming of the radio using the front panel connector J6. Length is 6 feet.

10535-0760-A006

Remote Control / Programming Cable, J9 Accessory Connector

This cable provides remote control and programming of the radio using the rear panel connector J9. The opposite end utilizes a 9-pin D style connector. Length is 6 feet.

10535-0730-A1

Remote Control and PA Control Y Cable, J6 Accessory Connector

This cable provides both remote control of the radio and control of a power amplifier using the front panel connector J6. The opposite end utilizes a 9-pin D style connector. Length is 10 feet.

POWER CABLES

10181-9833-004

RF-5051PS-125C to Amplifier Cable

This cable connects the RF-5051PS-125C Power Supply to either the 125-watt or 150-watt amplifiers. Length is 4 feet.

10181-9834-004

RF-50554PS to Amplifier Cable

This cable connects the RF-5054PS Power Supply to the 400-watt amplifiers. Length is 4 feet.

10181-9826-020

DC Power Cable – 125-Watt and 150-Watt Systems

This cable connects either the RF-5832H-PA001 125 watt amplifier or the RF-5833H-PA001 150 watt amplifier to DC power. Opposite end is unterminated. Length is 20 feet.

10181-9828-020

DC Power Cable – 400-Watt Systems

This cable connects the RF-5834H-PA001 400-watt amplifier to DC power. Opposite end is unterminated. Length is 20 feet.

10181-9831-009

AC Power Cable

This cable connects the RF-5051PS-125C to a standard US style AC outlet. Length is 9 feet. Two cables are required with the RF-5054PS Power Supply.

12027-0205-A020

DC Power Cable - RF-5851-AD001

The cable connects the RF-5851-AD001 to DC power. Length is 20 feet

10373-0030

DC Power Cable

This cable connects the RF-5056PS DC/DC Converter to the vehicle DC power source. Opposite end is unterminated. Length is 15 feet.

ANTENNA COUPLER CABLES

10181-9823

Antenna Coupler Control Cable (RF-382A)

This control cable connects the RF-382A Antenna Coupler to the Falcon II system. Standard lengths are 25, 75, 150, and 250 feet.

10181-9824

Antenna Coupler Coax Cable

This coax cable connects the RF-382A or RF-5382H-CU001 to the Falcon II system. Standard lengths are 25, 75, 150, and 250 feet.

12020-1460

Antenna Coupler Control Cable (RF-5382H-CU001)

This control cable connects the RF-5382H-CU001 Antenna Coupler to the Falcon II system. Standard lengths are 25, 75, 150, and 250 feet.

KDU EXTENSION CABLES

10511-0704-012

KDU Extension Cable – 6 feet

10511-0704-150

KDU Extension Cable – 75 feet



This cable allows the user to operate the KDU when removed from the front panel of the radio.

KDU MOUNT

11071-0900-04

KDU Gimbale Mount

The 11071-0900-04 KDU Gimbale Mount is used for remote mounting of the Keypad Display Unit (KDU) from the Falcon II Manpack radios. The mount can be used in vehicles or on a desktop. The KDU is easily unlatched from the radio and latched to the Gimbale Mount for installation. It is just as easily reattached to the radio for jerk-and-run operation. The Gimbale Mount can be used with the 10511-0704-012 6-foot KDU Extension Cable. Three 10-32 x 0.75 inch hex mounting bolts with washers and locking nuts, and five black cable ties are included to facilitate installation. KDU and cables not included.

PLGR CABLES

12005-0730-A006

PLGR Interface Cable

Cable to connect a PLGR to the radio via the front panel J2 Connector. Length is 6 feet.

AN/VIC3 INTERCOM CABLES

11088-0200-A006

VIC3 Interface Cable

This cable allows the AN/PRC-150(C) Manpack to interface receive and transmit audio (with a Keyline) to the AN/VIC3 Intercom System.

COAX CABLES

10513-0810

Coax Cable-N to N Connector

This low loss coax cable is for applications that require long runs over 250 feet. Coax is LMR 400 Cable. Specify length when ordering.

10513-0811

Coax Cable-N to BNC Connector

This low loss coax cable is for applications that require long runs over 250 feet. Coax is LMR 400 Cable. Specify length when ordering.

10513-0812

Coax Cable-BNC to BNC Connector

This low loss coax cable is for applications that require long runs over 250 feet. Coax is LMR 400 Cable. Specify length when ordering.

BATTERIES

10075-1345-01 (BB-590/U)

Rechargeable Nickel-Cadmium Battery



The 10075-1345-01 (BB-590/U) is a rechargeable nickel-cadmium battery that works well up to 50°C.

BB-390A/U

Rechargeable Nickel Metal-Hydrate Battery

The BB-390A/U is a rechargeable, nickel-metal hydrate battery that provides about 60% more capacity than a BB-590/U. Not recommended for use above 60°C.

BA-5590/U

Non-Rechargeable, Disposable Lithium Battery

The BA-5590/U provides approximately three times the operation life of the BB-590/U Rechargeable Nickel-Cadmium Battery. The BA-5590/U cannot be recharged, and is recommended for use in high temperature applications when temperatures exceed 55°C.

BB-2590/U Type

Rechargeable Lithium-Ion Battery

The BB-2590-type battery is a very high capacity, rechargeable, Lithium-Ion battery that provides up to 300% the energy density and 250% of the capacity of the BB-590/U. It is the same physical size, but is about 20% lighter than the BB-390 and BB-590 Batteries. The battery has a built-in battery life indicator. Use with Harris RF-5058-CH002 or RF-5058-CH006 Battery Chargers.

BATTERY CHARGERS

RF-5058-CH002

2-Bay Battery Charger/Conditioner

RF-5058-CH006

6-Bay Battery Charger/Conditioner

The RF-5058-CH00X Battery Charger/Conditioner family includes 2-bay and 6-bay versions that will charge and condition BB-590/U NiCd, BB-390/U NiMH, and BB-2590/U Type Li-Ion batteries. The charger units are identical except for physical size and weight and the number of batteries that can be simultaneously handled. A mixed combination of up to two (CH002 unit) or six batteries (CH006 unit) of these types can be simultaneously charged and/or conditioned. Indicators are provided to display the charge or conditioning status of each battery to the operator. The charging and conditioning cycles are automatic and will shut off when charging is completed or under faulty battery conditions. Typical charging times for fully discharged batteries vary with battery capacity, temperature, and battery age, but are typically 2.5 hours for BB-590, 4 hours for BB-390, and 6 hours for BB-2590 type batteries. The Charger/Conditioner is packaged in a waterproof case for transport and operation. The system operates on 95-260 VAC, 47 to 440 Hz, or 12 to 36 VDC autoranging. Includes Instruction Manual and a detachable DC power cable with alligator clips and a detachable AC cable with US NEMA 5-15P male on one end and IEC 60320 female on the other.

RF-5059-CH002

NiMH/NiCd Battery Charger/Discharger

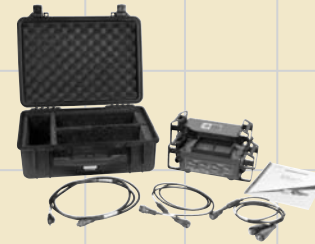

The RF-5059-CH002 is a quick-charger system for 10075-1345-01 (BB-590/U) and BB-390A/U batteries. It is powered by AC (95-265V) or DC (10-36V) power. AC and DC Input Cables should be ordered separately:

10488-1386-01	AC cable, U.S. (8 ft)
10488-1387-01	AC cable, Continental Europe (2.5 m)
10488-1388-A008	AC cable, UK (8 ft)
10488-1385-A005	DC cable, Alligator clip to charger (5 ft)

REMOTE CONTROL

RF-5800R-RC100

Remote Control System



LCU
(Shown on AN/PRC-150)

RCU

The RF-5800R-RC100 provides full remote control of the AN/PRC-150(C) up to a distance of 3.5-km over standard field wire. Full remote control of transmit and receive Audio, Data, and Control (using a keypad display unit) of the manpack is possible from the remote site. All functions controlled by the KDU are available from the Remote Control, including Automatic Link Establishment and modem selections.

The system supports the full range of data applications for the AN/PRC-150(C) including RF-6551H Tactical Chat, RF-6550H Radio Programming Application, and RF-6710W Wireless Messaging Terminal. It includes a Remote Control Unit RF-5800R-RC003 (RCU), A Local Control Unit RF-5800R-RC002 (LCU) Handset, Manual, and Carrying Bag. The RCU is powered by a single BA-5590, BB-390, or BB-590 battery. The RF-5800R-RC100 requires a 10518-1694-A006 cable for data applications.

12027-0050-075
Short Distance Remoting Kit

The short distance remoting kit allows remote audio and control of the AN/PRC-150(C) up to a distance of 75 feet. The 10181-5180-01 Amplified Speaker is used for audio and handset remoting. The kit includes three cables: a 10535-0707-075 for audio, a 10535-0706-075 for speaker power, and a 10511-0704-150 KDU Extension cable. The speaker requires an external 26 VDC power source.

AMPLIFIED SPEAKERS

10181-5180-01
Tactical Amplifier Speaker



Amplifies the audio output for vehicular applications. The speaker features dual 6-pin handset/headset connectors, individual handset/headset and speaker volume controls, individual handset/headset and speaker power switches, and a vehicular mounting bolt. It requires external 26-VDC power. Two cables are required (ordered separately).

1. Speaker power cables:

10535-0706-A009	9-foot long speaker to 4-pin power connector
10535-0706-A075	75-foot long speaker to 4-pin power connector
10535-0708-A009	9-foot long speaker to pigtail leads
10535-0708-A075	75-foot long speaker to pigtail leads
11068-0018-A009	9-foot long speaker to RF-5850 Battery Eliminator

2. Audio cable:

10535-0707-A009	audio cable that connects to the AN/PRC-150(C) Audio connector J1.
-----------------	--

BACKPACKS

10512-0465-01
FALCON II Backpack Carrying Bag

Designed for short duration, dismounted missions. This Olive Drab colored bag has pouches for accessories, antennas, and two additional batteries. The bag has holes in the top for deployment of the antennas, the Keyboard/Display Unit Extension Cable, the handset cable, and other accessory cables while the bag is closed.

10530-0460-01
Backpack Carrying Bag

This Olive Drab colored bag is heavily padded and designed for use in airborne jump applications. It has HERCULON reinforced areas, and has adjustable web to set the carrying depth of the radio. It has room to store cables and two spare batteries. Designed to fit inside a larger ALICE rucksack.

HANDSETS

10075-1399
Lightweight Handset - H-250/U (modified)



The 10075-1399 is a high-grade, lightweight MIL handset for use with the Falcon II tactical radio systems. One handset is supplied with each radio.

HEADSETS

RF-3020-HS001/HS002 Lightweight Headsets

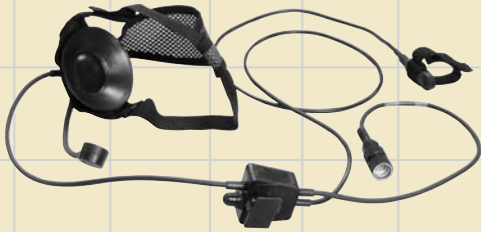

The RF-3020-HS001 headset is a lightweight tactical headset with a single earphone, a gooseneck boom mounted microphone, and a push-to-talk switch with a clothing clip for attachment. The RF-3020-HS002 (shown) is identical to the RF-3020-HS001, but has a second, silent push-to-talk button in sniper switch fashion. The headsets are rugged, submersible, and designed to meet tactical environmental requirements.

HUB BATTERY

B41-0010-003 Hold Up Battery (HUB) Replacement Hold Up Battery for the AN/PRC-150(C) radio. NSN 6135-01-461-5322

KDU WRIST STRAP

10512-0470-01 KDU Wrist Strap Assembly



Provides a strap assembly to mount the removable Keypad/Display Unit (KDU) from the radio to the left or right forearm using adjustable Velcro fasteners for size adjustment.

POWER SUPPLIES

RF-5051PS-125C Power Supply

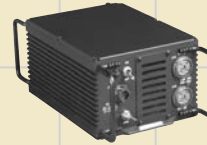

The RF-5051PS-125C provides power for the Falcon II 125-watt or 150-watt system in base station, shipboard, or transportable operation. DC output is 28-VDC nominal at 30 amps. Input is 115 or 230 VAC, 47 to 400 Hz. Requires 10181-9831-009 AC Power Cable. Use the 10181-9833-004 cable to connect the power supply to the 125-watt or 150-watt amplifiers.

RF-5054PS-400 Power Supply



The RF-5054PS-400 provides power for the Falcon II 400-watt systems in base station, shipboard, or transportable operation. Two RF-5051PS-125C power supplies are connected together to provide enough power for the 400-watt system. Input is 115 or 230 VAC, 47 to 400 Hz. Two 10181-9831-009 AC Power Cables are required. Use the 10181-9834-004 cable to connect the power supply to the 400-watt amplifier.

RF-5055PS AC/DC Power Supply



The RF-5055PS provides power for the Falcon II 125-watt and 150-watt systems in a low-profile package. The power supply accepts 115 or 230 VAC and supplies 26.4VDC at 18 amps. In 150-watt systems the duty cycle are restricted to 20%. When used with the RF-5056PS DC/DC Converter the RF-5055PS will supply power to the auxiliary power input of the RF-5056PS to conserve vehicular battery life when AC power is available. A 9 foot AC power cable is included.

RF-5056PS

DC/DC Converter



The RF-5056 DC/DC converter provides a regulated 26.5VDC at 20 amps peak when supplied with a 12VDC, 24VDC or 28VDC from a vehicle DC power system. In 150-watt systems the duty cycle are restricted to 20%. This DC/DC Converter will also accept an auxiliary power input from a RF-5055PS AC/DC Power Supply - when power is present at the auxiliary input, the RF-5056 converter shuts down to conserve the vehicle's battery life. The low profile design allows mounting under the RF-5055PS or the RF-5832H-PA001, sharing the same shock tray. The RF-5056 will also mount on the RF-5071VSM-03 Shock Mount for use in severe shock applications. No cables or mating connectors are provided. Use the 10373-0030 DC Power Cable for connection to the vehicle DC Power (order separately).

RF-5052PS

12/24 VDC Converter



The converter provides 26.5-volts DC at 17 continuous amps and 20-amps peak from a 12-volt DC source. It permits the operation of Falcon II 125- and 150-watt systems in vehicles with 12-volt electrical systems. It will not work with 400-watt systems. It is designed for mounting in engine compartments or other harsh environments. The converter includes a 15-foot DC input fused cable.

BATTERY ELIMINATOR/ DC POWER ADAPTER

RF-5850-PS001

Battery Eliminator



Used in place of the battery box to provide operation of the AN/PRC-150(C) from 85 to 270 VAC, 47 to 440 Hz, or 9 to 36 VDC. The power supply contains a battery to permit radio operation for short time periods without external prime power. The battery is recharged when external prime power is reapplied. The unit is supplied with both a DC power cable, and an AC power cable with a US style plug attached.

RF-5851-AD001

DC Power Adapter

Used in place of the battery box to provide operation of the AN/PRC-150(C) from 22- to 32-VDC. The adapter provides protection from overvoltage, undervoltage ripple, etc. and is designed to meet MIL-STD-1275. The 12027-0205-A020 (20 foot) DC Power Cable should be ordered separately.

SOFTWARE APPLICATIONS

RF-6710W

Wireless Message Terminal Software

When installed on a Harris- or customer-provided computer, the RF-6710W Wireless Message Terminal (WMT) forms a multi-media messaging system that provides transparent relay of e-mail and files over HF, operating like a standard PC with email. The RF-6710W automatically sends messages and data to the final destination, adaptively using different channels/frequencies.

RF-6550H

Radio Programming Application (RPA)

This software application allows the user to enter frequency, mode, ALE network information and other parameters into a Windows-based computer program and save it to a file. The program also downloads the operating parameter into a radio using a 10535-0775-A006 Asynchronous Data (PPP) cable. The computer file can program all the radios in a network. The RF-6550H RPA and 10535-0075-A006 cables are provided with each AN/PRC-150(C) manpack.

RF-6551H

Tactical Chat

This easy-to-use Windows-based computer program allows two stations to send and receive simple messages. Small data files can also be transferred. The RF-6551H will automatically link to the receiving station using the ALE function in the radio. Data is sent using the ARQ function – providing error-free transfer of the information. The RF-6551H Tactical Chat software and 10535-0075-A006 cables are provided with each AN/PRC-150(C) manpack.

SHOCK MOUNTS

RF-5870-VM001

Adjustable Shock Mount

This shock mount allows installation of the AN/PRC-150(C) Manpack into vehicular, shelter, or other applications that require shock isolation. The mount adjusts to allow the battery box, the RF-5850-PS001, or the RF-5851-AD001 to be used with the manpack.

RF-5870-VM002

Security Lock

This kit attaches to the RF-5870-VM001 to prevent unauthorized removal of the radio from the shock mount. Requires the use of a padlock (not included).

Frequently Asked Questions

How Much Power Do I need?

As a general rule, 20 watts from a manpack radio is good for ground wave distances and short links out to a couple of hundred miles. But the type of antenna used with the 20-watt manpack greatly influences this range. For 100 to 150 watts, the range is usually good for around 1,000 miles reliably or 2,000 miles intermittently. For 400 watts, the range can be around 2,000 miles, and more in good propagation conditions.

Try to think of power levels in this way. For areas up to 20 to 30 miles, use a 20-watt system. For reliable communications with an area the size of one half the continental United States; i.e., Rochester, NY to Atlanta, GA; consider using 150 watts. For communications for a distance roughly one coast of the US to the other, CONUS (i.e., New York City to Los Angeles); consider 400 watts. Occasionally, 400 watts will be good enough for OCONUS communication distances.

Again, these are rough guides for reliable communications. One could easily use 150 watts and communicate from one coast to the other given the right propagation conditions and antenna. There are exceptions to these guides as well. For example, to communicate in the 50- to 100-mile gray zone, 100 to 150 watts is generally needed.

My current system has higher power than 400 watts. Is the 400-watt system a suitable replacement?

The new 400-watt systems will usually provide enough power to communicate the same distances the older 500-watt to 1-kW systems did. Additionally the new waveforms provide additional gain to the system resulting in better performance and requiring less power output.

The new 400-watt systems are 400-watts PEP and average; they will put out 400 watts continuously. Some older systems also use vacuum tubes in their output stage, while the new 400-watt systems are solid state. This means the new systems are better suited to the functions that require fast tuning, Automatic Link Establishment, and frequency hopping and they don't require the maintenance annoyance of replacing tubes. See "How Much Power Do I need?"

"What is the difference between 2G- and 3G-Automatic Link Establishment?"

Third-generation ALE or 3G is the newest version of Automatic Link Establishment. It provides faster linking times, better linking in poor channels, and it allows for different channel plans for better networking, among

other features. 3G- and 2G-ALE are not compatible with each other.

How about maintenance of the Falcon II systems?

Maintenance of the Falcon II systems is based on module replacement. There are no operator replaceable components (tubes, etc.) in the systems. The operator can swap out the defective module and quickly return the system to service. Harris can help the customer develop a maintenance plan based on module replacement or complete radios (hot spares):

- The customer can simply return the defective radio to Harris for repair.
- Harris can supply a number of spare units to the customer. The customer would swap with a good unit they have in their supply and return the defective module or radio for repair. The defective unit is repaired and returned to the customer.
- Harris can maintain a supply of customer spare modules or complete radios. The defective units can be returned to Harris for repair while a spare unit is shipped to the customer for quick turn around. The defective unit is repaired and placed in the customer's stock.

Are the new systems compatible with the Scope Command Systems?

Yes, the new systems are compatible with the Scope Command System, provided they have firmware version 1.3 or greater. The Harris RF-6710W Software Wireless Messaging Terminal is also required.

Are the Falcon II systems LINK 11 compatible?

No.

How can I send data with the AN/PRC-150(C) radios?

The Falcon II systems have a number of high-speed HF modem waveforms built in. The radios have 39-Parallel Tone, Serial Tone, and other waveforms that allow data transmission up to 9600 bps over HF channels.

Do I need an external encryption device with the AN/PRC-150(C) radios?

The AN/PRC-150(C) radios have a number of encryption capabilities built in, no need for an external crypto unit. The radios are compatible with KY-99(A), KY-100, KG-84C, and KY-57 crypto devices. The same fill devices will also fill the AN/PRC-150(C). The radio also has coalition encryption based on Harris Citadel encryption that can interoperate with Harris RF-5800H HF manpacks used in many countries around the world.



RF Communications Division | 1680 University Avenue | Rochester, NY USA 14610 | Telephone 585-244-5830
| www.harris.com | 1-800-4-HARRIS ext. 3522